

PCE Datenblatt

Artikel-Nr.	0932-4v
Bezeichnung	CEE-Stecker 32A 3p 24/42VAC 100-200Hz IP67 TWIST
Langbeschreibung	CEE-Stecker 32A 3p 24/42VAC 100-200Hz IP67 TWIST Gehäusematerial: PA6 Nennstrom: 32A Polzahl: 3 (3P) Uhrzeit-Stellung: 4h Nennspannung/Frequenz: 24/42V~ / 100-200Hz Kontakte: Messing vernickelt Anschlusstechnik: Schraubklemmen Schutzart: IP67
GTIN (EAN)	9003399113765
Ursprungsland	AT
Zolltarifnummer	85366990
Nettogewicht	0,169 kg
Verpackungsmenge	10
Mindestbestellmenge	10

ETIM 7.0	EC000140
IEC-Stromstärke	32 A
Polzahl	3
Spannung nach EN 60309-2	20-25 V / 40-50 V (100-200 Hz) grün
Uhrzeit-Stellung	4 h
Kennfarbe	grün
Schutzart (IP)	IP67
Anschlusstechnik	Schraubklemme
Kabeleinführung	Verschraubung
Steckrichtung	gerade
Werkstoff	Kunststoff

a	135 mm
b	71 mm
K (Kabel Ø)	9,5-24 mm
SW	48 mm
Leitung flexibel	1-10 mm ²
Kontaktschrauben	160 Ncm
Zugentlastung	600 Ncm
Abmantellungsänge	70 mm
Abisolierlänge	14-16 mm

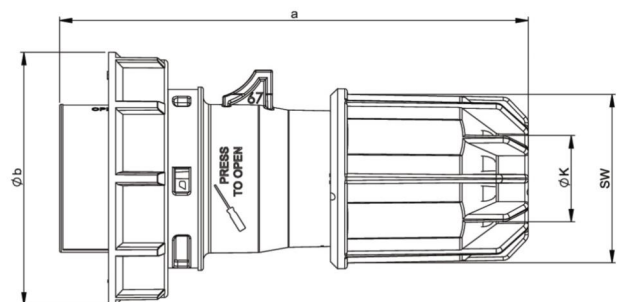

www.manufacturer-safety.info